

Items Supplied >

- 1 - FRONT HEADPIPE W/ HEATSHIELD
- 1 - REAR HEADPIPE/COLLECTOR W/ HEATSHIELD
- 1 - COLLECTOR HEATSHIELD
- 1 - MUFFLER ASSEMBLY
- 1 - BRACKET, EXHAUST MOUNT
- 6 - CLAMP, HS-24 (SMALL)
- 1 - CLAMP, HS-28 (LARGE)
- 1 - CLAMP, 27-61MSC 1 - CLAMP, 268-65MSC
- 2 - BOLT, 5/16" X 1/2" FLANGE W/ LOCK PATCH

Application(s) >

HARLEY:

SPORTSTER 883 IRON	14-20
SPORTSTER 883 SUPERLOW	14-20
SPORTSTER 1200 CUSTOM	14-20
SPORTSTER 1200 SUPERLOW	14-20
SPORTSTER 1200 ROADSTER	16-20

NOTE: WILL NOT FIT BIKES WITH FORWARD CONTROL FOOTPEGS.

Instruction Manual >

6493

Page 1 of 3

PRIOR TO INSTALLATION, MAKE SURE YOUR STOCK HEAD PIPE GASKETS ARE IN GOOD CONDITION. IF YOU HAVE ANY DOUBTS AS TO THEIR CONDITION, REPLACE THEM.

Read all instructions carefully and completely before installing your new exhaust system!

1. Apply masking tape to any surrounding parts to protect them from getting scratched.
2. Unplug O₂ sensors on front and rear headpipes from motorcycle wire harnesses.
3. Remove the stock exhaust system being careful not to damage the headpipe gaskets. If the headpipe gaskets are in good condition they do not need to be removed from the cylinders. Remove and save the flanges, nuts, retaining rings and O₂ sensors from the stock exhaust.
4. Remove the sprocket cover. You will need to remove the foot peg mount to gain clearance to remove the sprocket cover.
5. Remove the stock exhaust mount bracket.
6. Install the supplied exhaust mount bracket using the stock bolts. See **FIGURE 1**. Tighten the bolts to factory specifications.
7. Reinstall the sprocket cover and foot peg mount. Tighten to factory specifications.

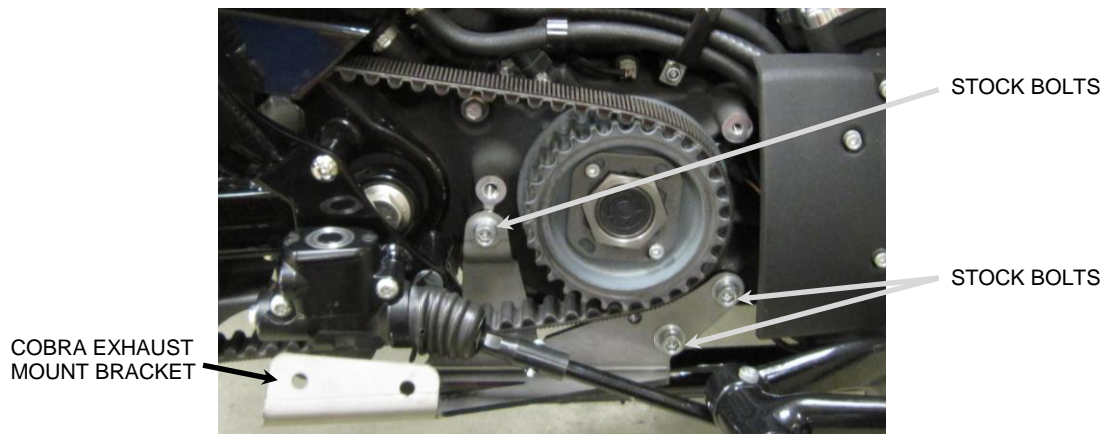

FIGURE 1

Continued on Page 2

DISCLAIMER: NOT LEGAL FOR SALE OR USE IN CALIFORNIA ON ANY POLLUTION CONTROLLED MOTOR VEHICLE. THE SALE, USE, OR INSTALLATION OF THIS PRODUCT MAY ALSO BE ILLEGAL NATIONWIDE UNDER THE FEDERAL CLEAN AIR ACT (42 U.S.C. § 7522(A)(3)).

8. Install the stock flanges, retaining rings and O₂ sensors onto the supplied front and rear headpipes.
9. Install the front headpipe (with stock gasket in place) onto the front cylinder using the stock nuts but **DO NOT TIGHTEN** at this time.
10. Position the supplied #27-61 MSC clamp with hex head facing the direction shown in **FIGURE 2** over the inlet of the collector on the rear headpipe.
11. Install the rear headpipe and collector assembly (with stock gasket in place) onto the rear cylinder and slide the lower collector inlet on to the front headpipe. Use the stock nuts to fasten the rear headpipe to the cylinder but **DO NOT TIGHTEN** at this time. Make sure the front headpipe is pushed in as far as possible into the inlets of the collector on the rear headpipe.
12. Position the muffler clamp with hex head facing the direction shown in **FIGURE 3** over the inlet of the muffler.
13. Slide the muffler onto the outlet of the rear headpipe and collector assembly until the holes in the muffler mount align with the exhaust bracket. Position the holes so they are in the center of the slots.
14. Secure the muffler assembly to the exhaust mount bracket using the (2) supplied 5/16"-18 bolts but **DO NOT TIGHTEN**.
15. Make sure the muffler assembly, front headpipe, and rear headpipe are aligned properly and tighten in the following order; headpipe flanges to the cylinders (slowly tightening opposing nuts), front headpipe clamp, muffler clamp, and finally the muffler assembly to the exhaust mount. (NOTE: The muffler clamp and headpipe clamp should be flush with the end of the inlets when tightened. See **FIGURE 2 & 3**. If the clamps are slid past the slots on the inlets the clamps will not tighten properly).

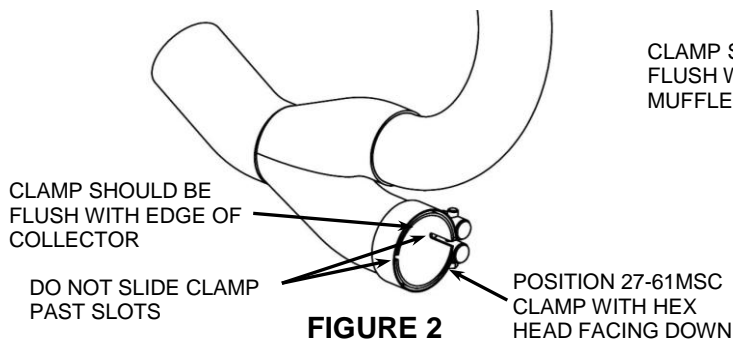

FIGURE 2

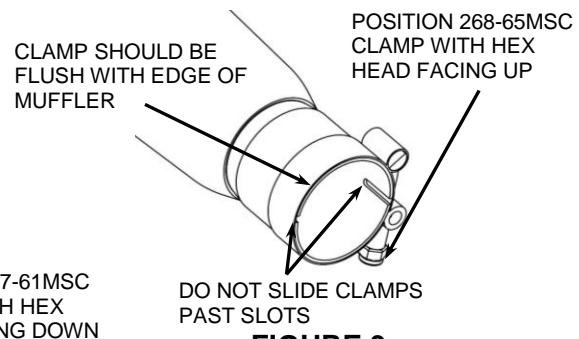
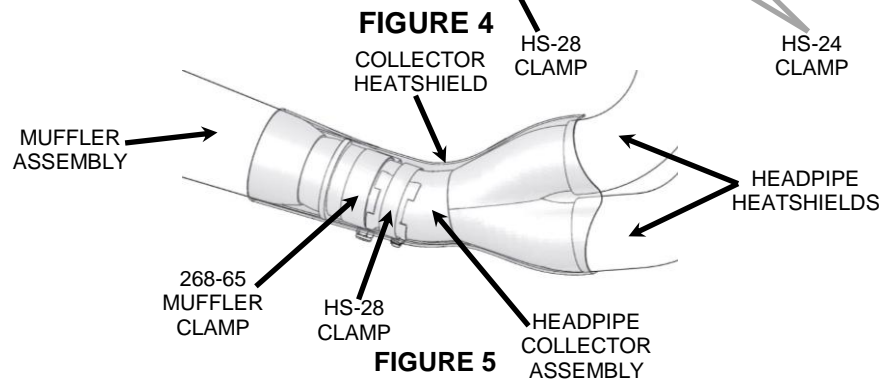
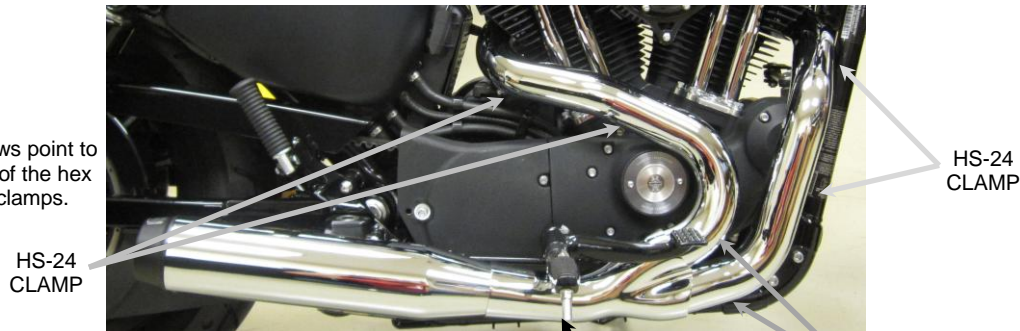

FIGURE 3

16. Plug the O₂ sensors back into motorcycle wire harnesses.
17. Unscrew the small **HS-24** clamps and feed the tail end of the clamp through the clips on the inside of the heatshields. See **FIGURE 4** for proper positioning of the clamps on the heatshields. (NOTE: The arrows point to the positioning of the hex head of the clamps. The hex head of the clamps should be accessible for tightening but not visible when the heatshields are mounted to the pipes.)
18. Unscrew the larger **HS-28** clamp and insert the tail end through the clip on the inside of the collector heatshield. See **FIGURE 4** for proper positioning of the clamps on the heatshields. (NOTE: The arrows point to the positioning of the hex head of the clamps.)
19. Install the rear heatshield first. Slide the bottom of the heatshield into position first and then slowly push the top of the heatshield into position. (NOTE: Spread the hose clamps apart slightly to make it easier to slide them over the muffler assembly and headpipes.) Snug the heatshield clamps but do not tighten. See **FIGURE 4**.
20. Install the front heatshield the same way as the rear heat shield. See **FIGURE 4**.

Continued on Page 3

NOTE: Arrows point to the position of the hex head of the clamps.



21. Install the collector heatshield over the collector area by first inserting the rear portion over the front of the muffler inlet and then carefully sliding it backward over the muffler body. See **FIGURE 4 & 5**. The front of the collector heatshield will go over the rear portion of the headpipe heatshields. Adjust the heatshield fore and aft on the collector so there is a small and even gap between the rear of the collector heatshield and the front of the muffler body. The muffler may need to be slid forward or backward on the mounting bracket to increase or decrease the size of the gap. Also be sure to rotate the front of the collector heatshield on the collector so that it sits on both the front and rear headpipe heatshields evenly. **NOTE:** The headpipe heatshields may need to be adjusted fore and aft and or rotated on the headpipes to allow the collector heatshield to align properly.
22. When the heatshields are aligned properly, tighten the clamps on the front and rear heatshields first. Then tighten the collector heatshield clamp last.
23. Make sure all the hardware (brackets, head pipes, heatshields, and floorboards) has been tightened appropriately.
24. **IMPORTANT:** Before starting your engine remove all fingerprints from chrome with a quality wax or chrome polish. Failure to do so can cause chrome discoloration. Due to fluctuations in fuel delivery settings, timing, etc., Cobra Engineering does not warrant against chrome discoloration. Clean the black exhaust tip with a mild dishwashing soap and a soft cloth. Avoid abrasive cleaning methods such as granular or dry cleansers, simple green, scotch-brite or steel wool pads. Abrasives may breach the coating and shorten life.
25. Check the tightness of the two button head bolts securing the billet tip to the muffler after the first ride, 100 miles, and every 500 miles after that.