

Items Supplied >

- 1 – FREEWAYBAR
- 2 – CLAMP, POWDERCOATED
- 2 – SCREW, BUTTONHEAD M10 X 40 mm
- 2 – NUT, NYLOCK 10 mm
- 1 – SPACER, BLUE ZINC
- 1 – BOLT, FLANGED M6 X 25 mm

Application(s) >

KAWASAKI VN900

06-19

Instruction Manual >

01-1468A

Page 1 of 1

Read all instructions carefully before installing your new Cobra® product!

1. Remove wires from horn. Remove M6 bolt and horn from frame. Remove the M6 bolt securing the sensor mount under the right front side of fuel tank, near front of frame, see Figure 1, it will not be reused. Install supplied M6 x 25mm bolt through Horn Mount, note orientation of horn, supplied zinc spacer, sensor mount, and into frame mount, tighten to factory specifications, see Figure 1. Rotate horn as needed to install horn wires and tighten. Make sure horn is in good working order.
2. Remove the front (2) M10 bolts from the left and right floorboard mounts. Slide freeway bar between the frame and front fender with the lower mounting brackets facing to the rear. Align lower mount holes with floorboard mount holes and re-install M10 bolts to frame and snug so bar remains upward, see Figure 2.
3. Slide upper mounts between frame rails and place the supplied billet clamp on the outside of the frame. Align hole and insert the supplied M10 buttonhead bolt through clamp, mount, and into supplied M10 locknut and snug. Repeat on opposite side.
4. Make sure freeway bar is aligned properly and tighten the M10 clamp bolts making sure clamps do not rotate on frame tube. Tighten the (2) lower M10 floorboard bolts to factory specifications.

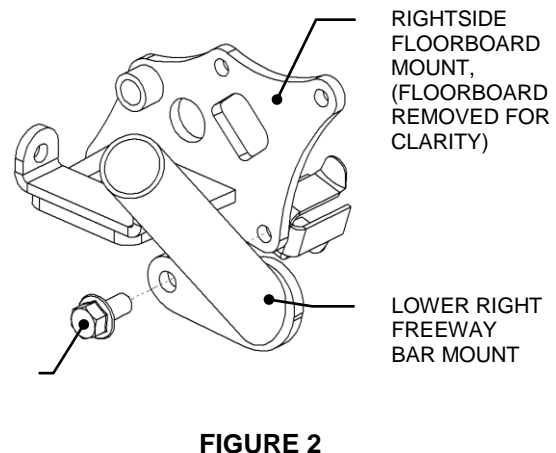
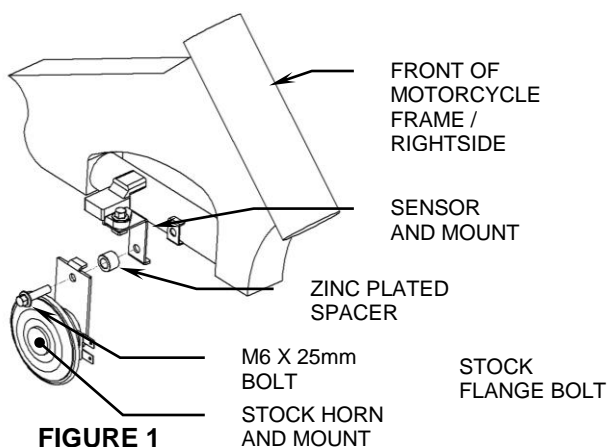

* Cobra® recommends you always wear a helmet while riding. Please never operate your motorcycle while under the influence of alcohol and/or drugs. Enjoy the new look of your motorcycle and please ride safely.