



Items Supplied >

- 1 - Sissy Bar with Pad
- 2 - Detachable Side Plates (Left/Right) Chrome or Black
- 2 - 3/8" I.D. Front, Mount Bushing Chrome
- 2 - 3/8" I.D. Rear, Mount Bushing Chrome
- 4 - 3/8"-16 x 2-3/4" Flathead Screws Zinc
- 4 - M8 x 16mm Buttonhead Screws

Application(s) >

HARLEY:
 SOFTAIL: FLSB 18-20

Instruction Manual >

602-2051 / 602-2051B

Page 1 of 3

Read all instructions carefully before installing your new Cobra® product!

1. Prepare a large towel or moving blanket to set the removed saddlebags on. Start on the right side of the motorcycle. Open the saddlebag lid, disengage rear mounting cam so red flag faces up on inner side of saddle bag, read H.D. owner's manual if needed. Carefully remove the right saddlebag making sure not to scratch exhaust with the lower front saddlebag mount.
2. Remove the front bolt and saddlebag bushing from the right side fender rail, these will not be reused. **NOTE:** Remove one side only so the fender does not fall resulting in possible scratches or damage to the fender or paint, see **FIGURE 1**.
3. Insert (1) 3/8"-16 x 2-3/4" supplied screw into (1) supplied front mount bushing. Place sufficient blue Loctite on the screw threads. Install the screw and bushing into the front fender rail hole. Snug but do not tighten, see **FIGURE 2**.
4. Remove the right rear fender rail screw and saddlebag bushing, these will not be reused, see **FIGURE 1**. Insert (1) 3/8"-16 x 2-3/4" supplied screw into (1) supplied rear mount bushing. Place sufficient blue loctite on the screw threads. Install the screw and bushing into the rear fender rail hole. Snug but do not tighten, see **FIGURE 2**.

REMOVE STOCK
REAR BOLT /
SADDLEBAG
BUSHING



REMOVE STOCK
FRONT BOLT /
SADDLEBAG
BUSHING

FIGURE 1

CONTINUED ON PAGE 2

** Cobra® recommends you always wear a helmet while riding. Please never operate your motorcycle while under the influence of alcohol and/or drugs. Enjoy the new look of your motorcycle and please ride safely.*

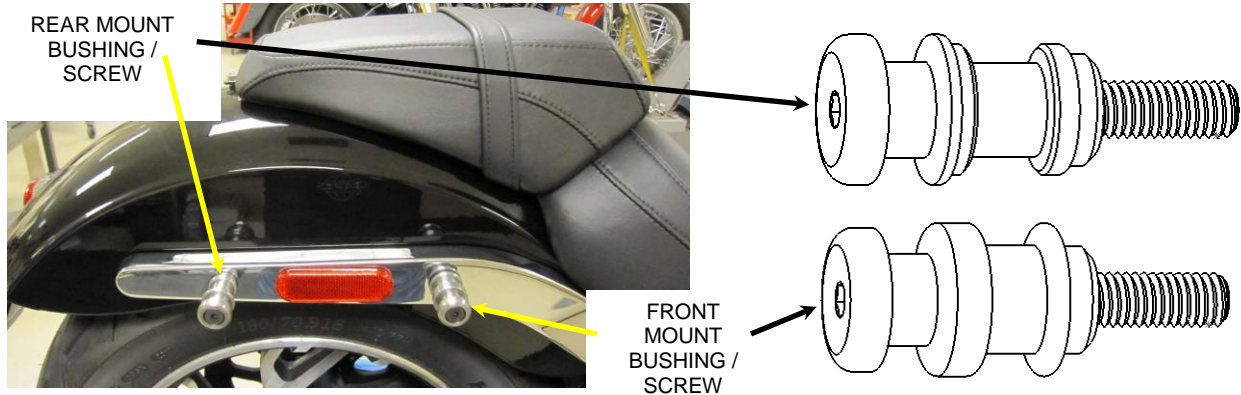

FIGURE 2

5. Repeat Steps 1-4 on the left side, exercising care while removing left saddlebag.
6. Install the supplied side plates on to the sissy bar with the four M8 X 16 mm button head bolts. Make sure the u-shaped grommets are facing the same direction (forward), as the sissy bar pad and the part numbers are facing inward. See **FIGURE 3**. Snug the bolts but **DO NOT TIGHTEN** at this time.

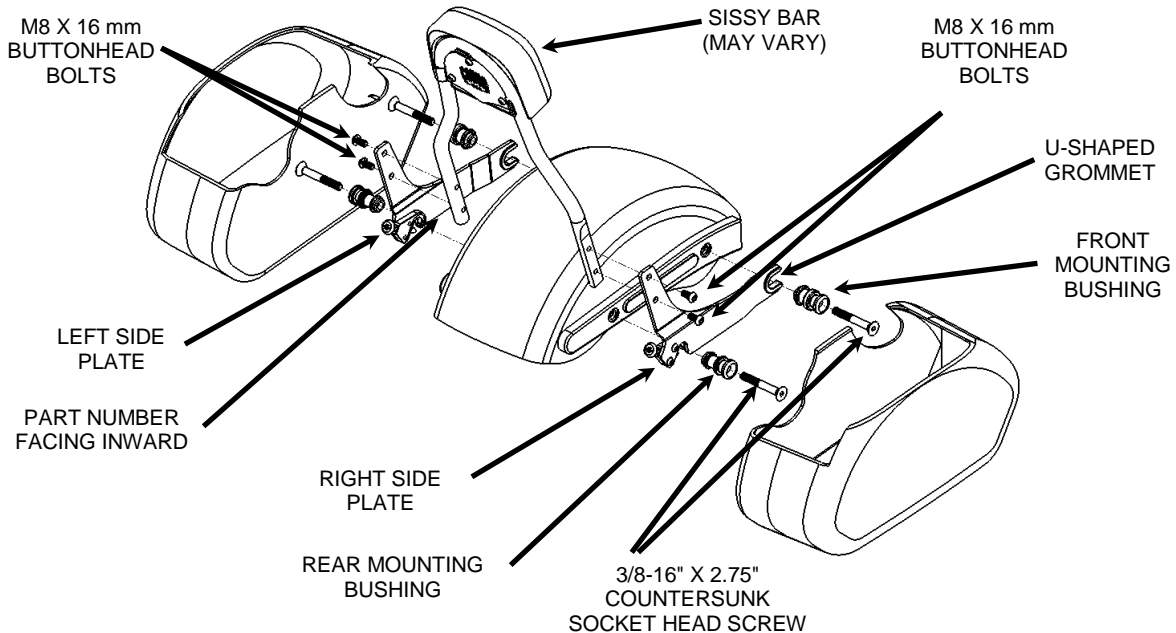

FIGURE 3

7. Install the sissy bar onto the bike by first inserting the front portions of the side brackets on to the front mounting bushings on the frame rails. Make sure the sissy bar is seated all the way onto the mounting bushings. See **FIGURE 4**.
8. Slowly rotate the sissy bar downward so the rear portions of the brackets slip over the rear mounting bushings. See **FIGURE 4**.

CONTINUED ON PAGE 3

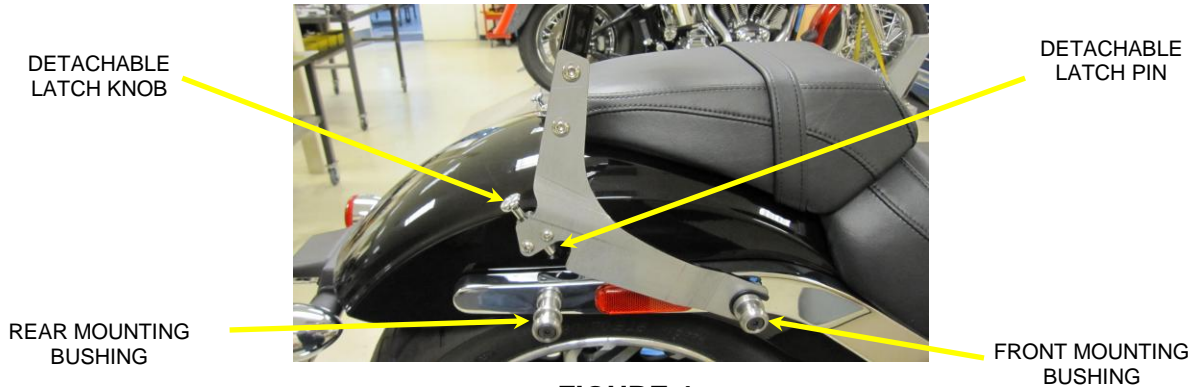

FIGURE 4

9. Pull backward on both detachable latch knobs and then push downward on the backrest to allow the backrest to sit completely on the rear mounting bushings. Then release the detachable latch knob to fully engage the latch pin underneath the mounting kit bushing. See **FIGURE 5**.
10. Always check to make sure both detachable latch pins are fully engaged on the bottom of the mounting kit bushing. Failure to fully engage the detachable latch pin could cause the backrest to come loose while riding. See **FIGURE 5**.
11. Pull backward on the top of the sissy bar and then tighten all four M8 X 16mm bolts. See **FIGURE 5**.
12. **TIGHTEN**, the 3/8"-16 x 2-3/4" front and rear mounting bushing screws fully to Harley original torque specifications for fender rail screws. Verify, Loctite was used on all (4) 3/8" screws.
13. Before each ride, check to make sure the detachable latches are fully engaged underneath the mounting bushings.
14. Check the tightness of all the screws after the first ride and after the first 500 miles.
15. Reinstall saddlebags on left and right sides of new bushings, be sure the lock cam engages securely on rear bushing. If initially tight to get on, tap on with palm of hand from rear and will loosen up with time.

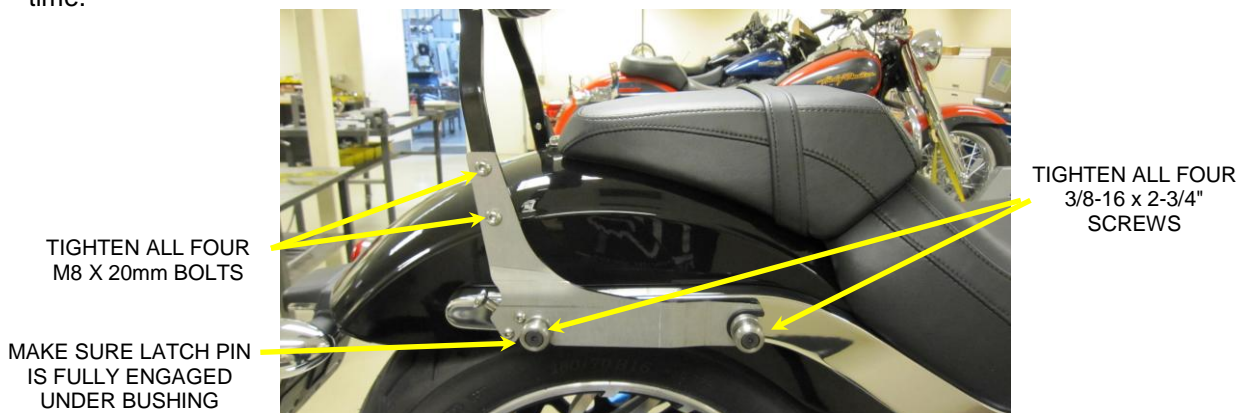

FIGURE 5

To clean your black accessory use a liquid based soap detergent, such as dishwashing soap applied with a soft cloth and rinse with clean water. Note: Avoid abrasive cleaning methods such as granular or dry cleansers, simple green, Scotch-Brite or steel wool pads. Abrasives may breach the coating and shorten life.